

RED LINE SERIES

# RB23 DD

## GLASSWASHER

### DESCRIPTION

Single phase glasswasher, single skin execution, electromechanical controls with push down buttons, voltage 230V – 50 Hz, two wash cycles, double-walled insulated front door, rotating top and bottom wash system, deep drawn tank, Thermostop-function for guaranteed temperatures, built-in detergent and rinse aid dosing pumps.



### STANDARD FEATURES

#### DURABILITY

- Stainless steel execution AISI 304.
- Double-walled insulated door.
- Rear panelling.

#### FLEXIBILITY

- Various racks and inserts
- Built-in detergent and rinse-aid dosing pumps

#### HYGIENE

- Deep drawn tank.
- Easily removable rotating top and bottom: polypropylene washing system.
- Filtering system: Compact filtration system + microfilter
- Flat rack guides: for easy cleaning operations. Strong and resistant, they are designed for intensive operations. Thickness: 1,5 mm.

#### SAFETY

- Magnetic microswitch to stop the cycle in case of accidental door opening.
- Thermostop as a standard: it ensures that the correct operating temperatures are reached.
- Mechanical thermostat to adjust boiler and tank temperatures.

#### EASE OF USE

- Select from two wash cycles. (fast - intensive)
- Electromechanical controls and push down buttons.
- LED Indicator for diagnostics:  
GREEN = Cycle in progress  
FLASHING GREEN = alarm

# RB23 DD

## STANDARD

### RACK EQUIPMENT

- 1 Combination rack 350 x 350 mm, h. 120
- 1 Cutlery holder, two places
- 1 Insert for cup dishes (15 Insert)



COMBINATION RACK



















G

### OPTIONAL ACCESSORIES

- Drain pump kit (provided separately)
- Special Voltages on request
- Water Softener - External

# RB23 DD

## TECHNICAL DATA

	EXTERNAL SIZE	430 x 521 x 613 mm
	OVERALL SIZE	791 mm
	CLEARANCE	220 mm
	RACK SIZE	350 x 350 mm
	ELECTRICAL SUPPLY	230V ~ 50Hz
	WASH PROGRAM LENGHT	90/120"
	MAX OUTPUT - WARM WATER CONNECTION (15 C°) ●	27/27 racks/h
	MAX OUTPUT - COLD WATER CONNECTION (15 C°) ●	11/11 racks/h
	RINSE WATER CONSUMPTION	2,5 l
	TANK HEATER ELEMENT	2 kW
	BOOSTER HEATER ELEMENT	2,8 kW
	TANK SIZE	11 l
	WASH PUMP	0,26 kW
	INSTALLED LOAD	3,06 kW
	NOISE	61 dB(A)
	WEIGHT	37 kg

# RB23 DD

## TECHNICAL DRAWINGS

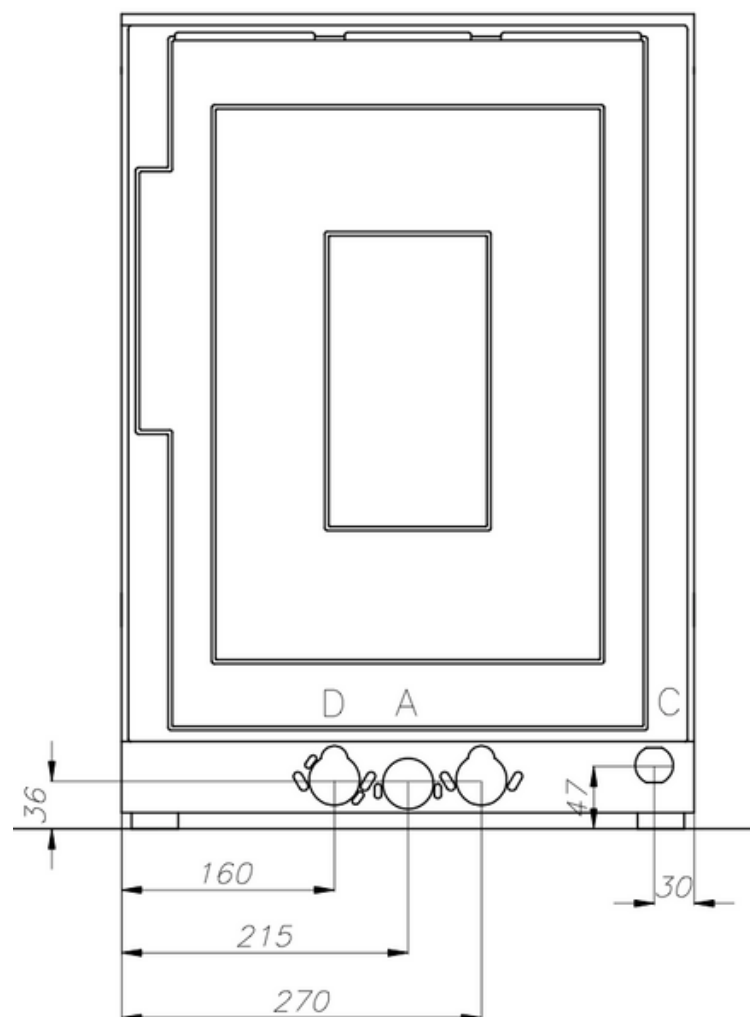
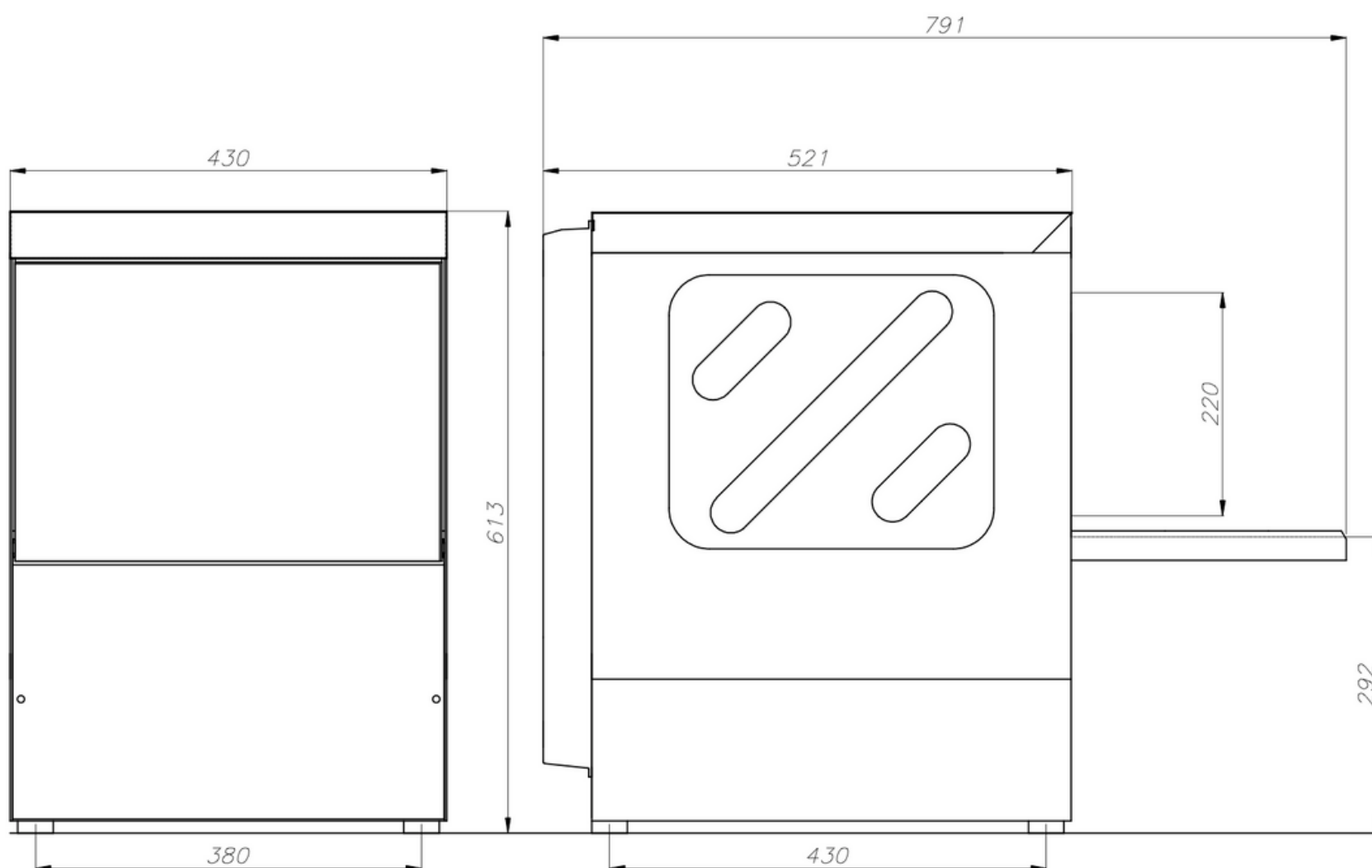

The stated values may deviate depending on installation conditions and items washed.  
Comenda Ali Group srl reserves the right to modify product specifications at any time without prior notice.