

INFINITY RANGE

YB35 R

UNDERCOUNTER GLASSWASHER

DESCRIPTION

Multipower glasswasher - double skin execution - Built-in dosing units and drain pump. Wris®2+ - Wash and rinse integrated system - RCD: rinse control device as a standard. Wi-Fi connectivity and “Comenda Cloud Washing” App and Web Portal for remote monitoring.



STANDARD FEATURES

RELIABLE.

- AISI 304 stainless steel double skin execution;
- Deep drawn double skin insulated counterbalanced door;
- Stainless Steel Rear Paneling;

SIMPLE.

- Full touchscreen graphic interface;
- 5 different programming options;
- Electronic adjustment of the detergent and rinse aid dosing pumps from the control panel;
- Simplified diagnostics: three different colors to show the type of alarm in progress;
- The intuitive START button features clear cycle monitoring with colour-coded status indicator to help your operations to run at its best;

HYGIENE

- TH LABEL program is standard for all infinity models;
- Partial water draining before rinsing;
- RCD- Rinse Control Device;
- Self-cleaning cycle at unit switch-off;
- Rack sliding guides;
- Single piece deep drawn tank;
- Self-draining wash pump;
- Triple filtration system: stainless steel surface filter, polypropylene basket filter and stainless steel mesh wire micro-filter.

FLEXIBLE.

- Multipower;
- Built-in drain pump and peristaltic dosing units
- Provision for peak power reduction connection (PCE)

YB35 R

STANDARD FEATURES

WI-FI AND BLUETOOTH CONNECTIVITY & REMOTE MONITORING

The new Wi-Fi and Bluetooth Pack allows the operator to easy monitoring the machine functions and access a vast amount of information; prevent possible failures by managing the anomalies in real time from smartphone, tablet and PC and keep consumptions under control.

COMENDA CLOUD WASHING APP E WEB PORTAL

Simple and intuitive gives you the power to:

- Check the main operating parameters of the unit;
- Start/stop the washing cycle;
- Download Records and HACCP reports;
- Access the alarm list and manage the anomalies;
- Check and download technical documentation;
- Save unit specific parameters or data settings;
- Adjust temperatures and dosage for chemicals;
- Plan the calls out for fixing only if necessary;
- Develop periodic reports for the end user;
- Make a remote assessment of wear parts

STANDARD RACK EQUIPMENT

RACKS AND INSERTS

- Inclined glass rack 500 x 500 mm



















YB35 R

OPTIONAL

- Upper rack holder
- Base stand with door
- Stand feet kit (for base stand)
- External water softener
- Reverse osmosis unit - external
- Detergent and rinse aid level probe kit
- 7 kW booster
- Special voltages

YB35 R

TECHNICAL DATA

	EXTERNAL SIZE	600x605x720 (AxBxC) mm
	OVERALL SIZE	940 (D) mm
	CLEARANCE	300 (E) mm
	RACK SIZE	500x500 mm
	ELECTRICAL SUPPLY	230V/50Hz; 230V/3/50Hz; 400V/3N/50Hz
	WASH PROGRAM LENGHT	90/90/120/240/150 "
	MAX OUTPUT - WARM WATER CONNECTION (55 C°) ●	40/40/30/15/24 racks/h
	MAX OUTPUT - COLD WATER CONNECTION (15 C°) ●	25/25/25/15/17 racks/h
	RINSE WATER CONSUMPTION	2,5 l
	TANK HEATER ELEMENT	1,2 kW
	BOOSTER HEATER ELEMENT	5 kW
	TANK SIZE	10 l
	WASH PUMP	0,65 kW
	INSTALLED LOAD	6,85 kW
	NOISE	61 dB(A)
	WEIGHT	59 kg

YB35 R

TECHNICAL DRAWINGS



YB35 R

TECHNICAL DRAWINGS

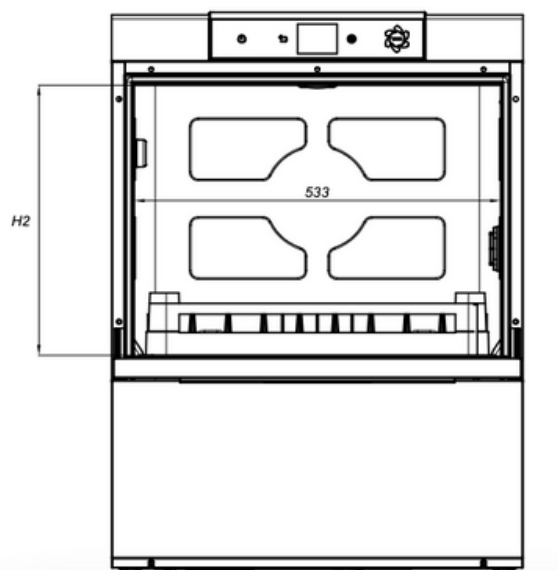
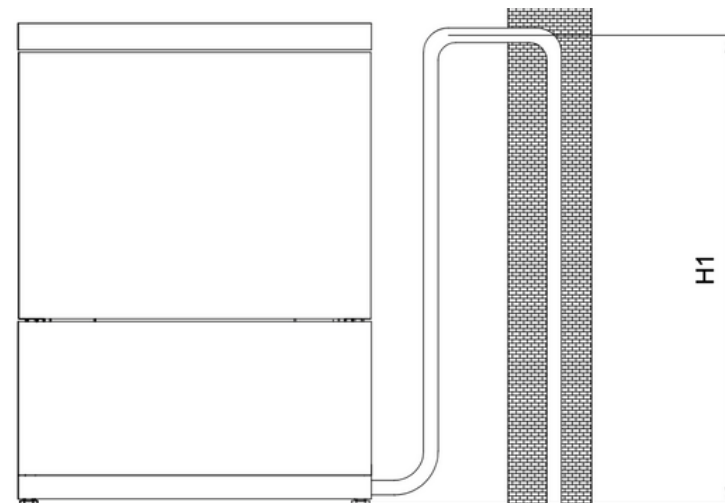
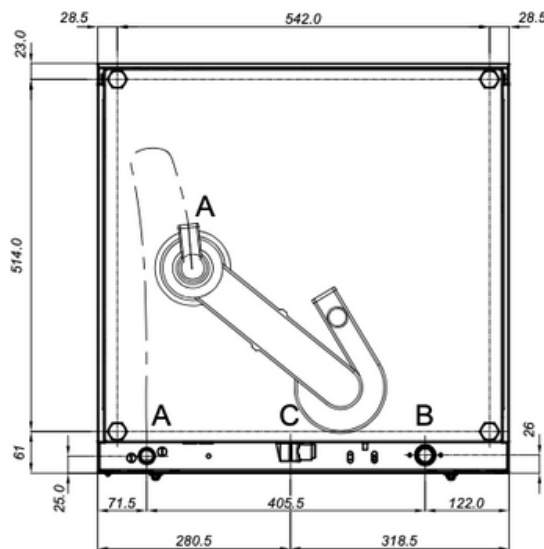
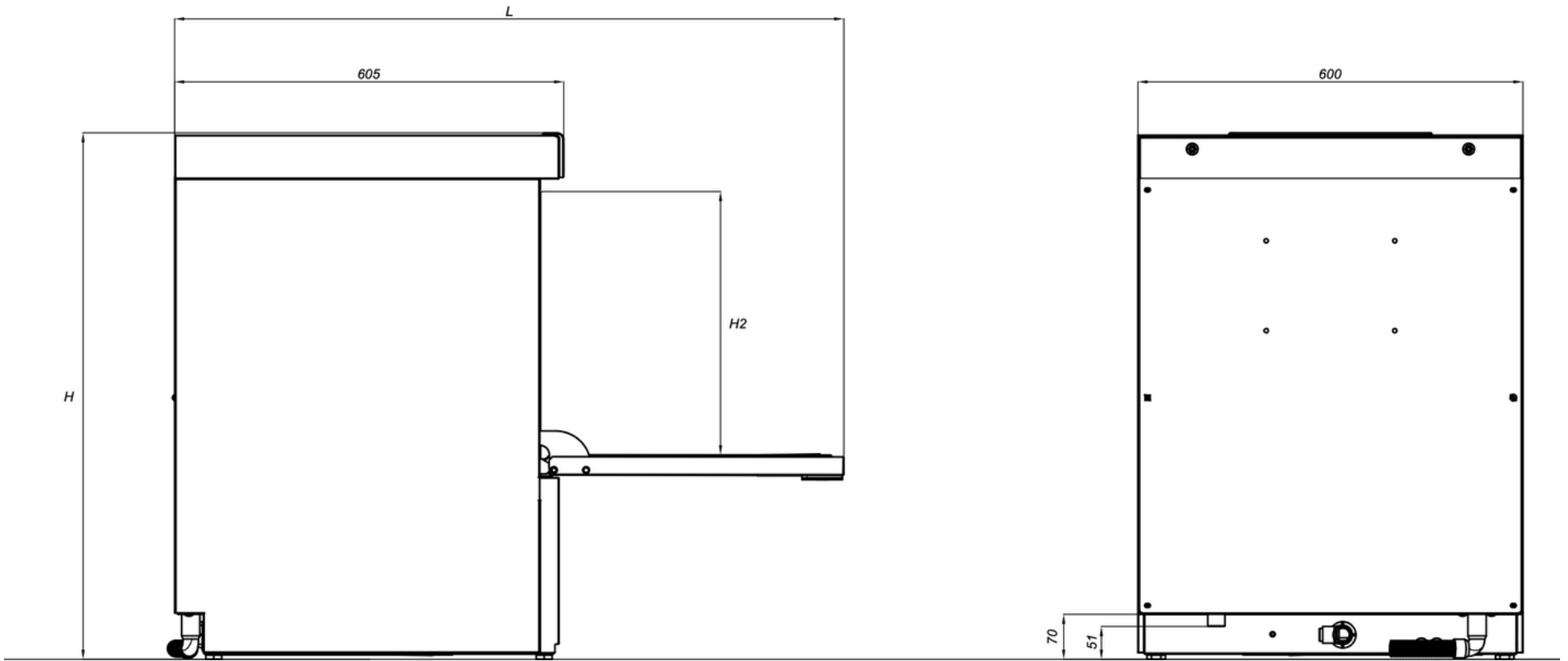

MODELLO / MODELE / MODEL / MODELL	L	H	H1	H2
YB35-R	940	720	550	300
YB35-RO	940	825	650	300
YF45-R	1040	820	650	400

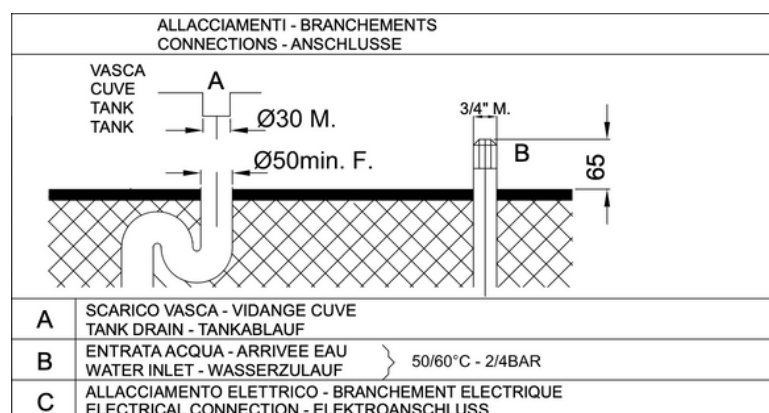

The stated values may deviate depending on installation conditions and items washed.
Comenda Ali Group srl reserves the right to modify product specifications at any time without prior notice.